

VAN WEEL KOELTECHNIEK B.V.

Address: Hoofdweg 92
2908 LC - Capelle a/d IJssel
Business: 010 450 30 84
Mobile: 06 518 36 116
E-Mail: aad@vanweelkoeltechniek.nl
Website: vanweelkoeltechniek.nl

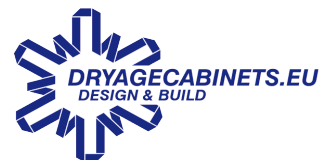

Dry Age Cabinet DACxDW-XL

RESUME

TECHNICAL SPECIFICATIONS

Plug & Play -
Fully Electronically Controlled DAC System -
Power Consumption depends on Size -
230 Volt | 50 Hz -
134A Refrigerant -

EXTRA OPTIONS

- Lightfilters
- Standing Meat Rack
- Rack for Hanging Meat
- Adjustable Measurements
- Look & Feel as desired

DIMENSIONS

Given measurements are an indication. Sizes can be made as required.

1-DOOR

D 95cm x **B** 94,5cm x **H** 230cm
D 37inch x **W** 37inch x **H** 91inch

2-DOORS

D 100cm x **B** 180cm x **H** 230cm
D 39inch x **W** 71inch x **H** 91inch

3-DOORS

D 100cm x **B** 270cm x **H** 240cm
D 39inch x **W** 106inch x **H** 95inch

MEAT RACKS

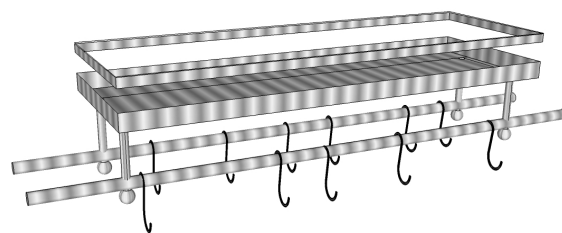
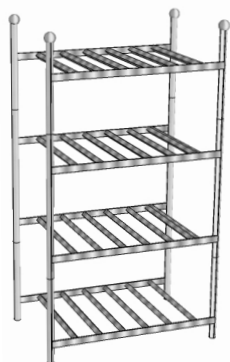
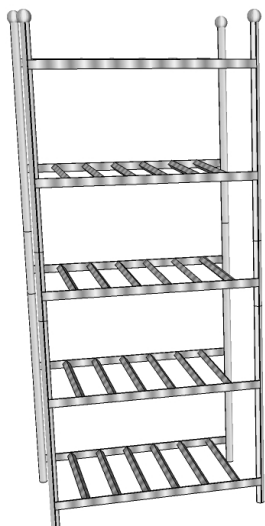

VAN WEEL KOELTECHNIEK B.V.

Address: Hoofdweg 92
2908 LC - Capelle a/d IJssel
Business: 010 450 30 84
Mobile: 06 518 36 116
E-Mail: aad@vanweelkoeltechniek.nl
Website: vanweelkoeltechniek.nl

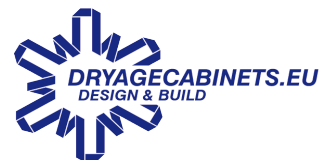

**Dry Age Cabinet
DAC2DW-XL**

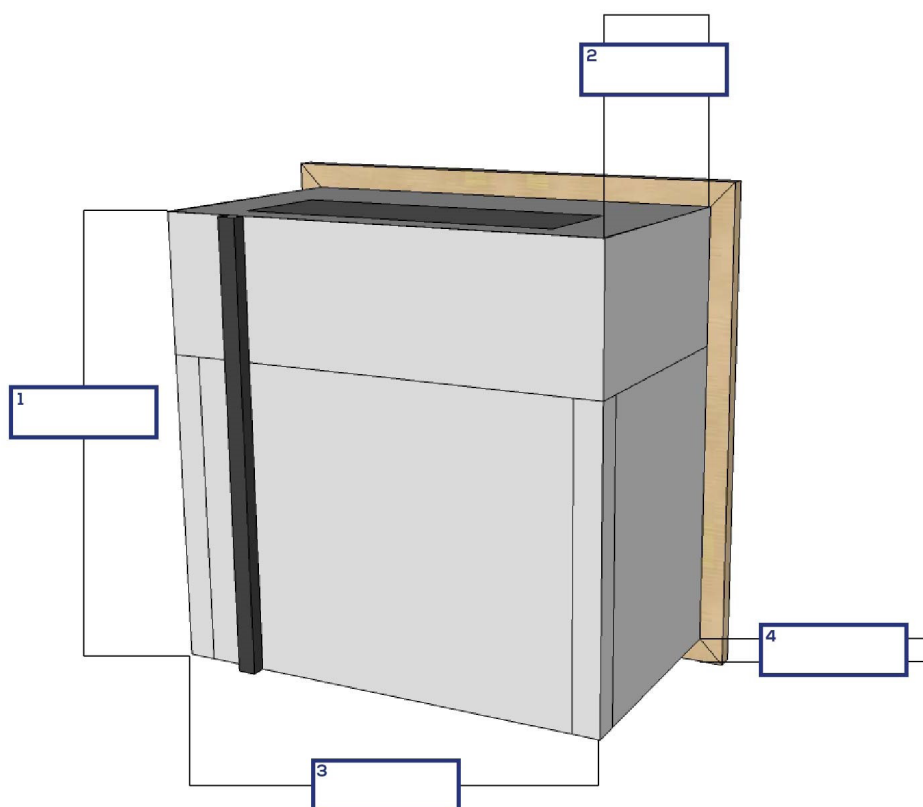
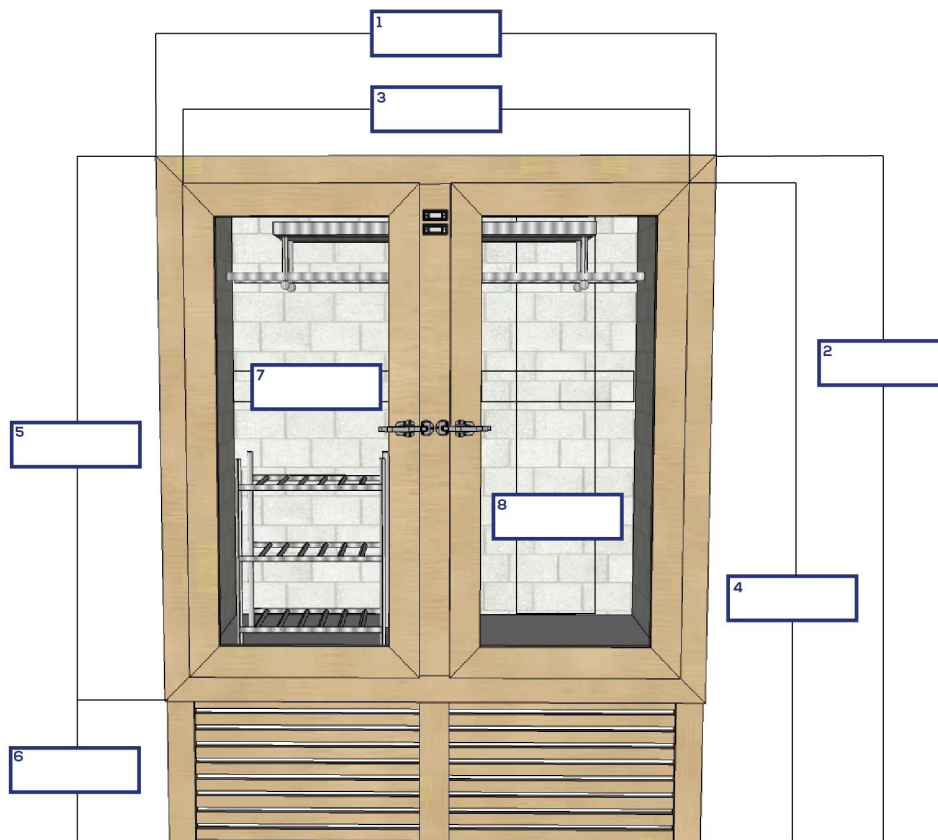

General Delivery and Payment Conditions following the N.V.K.L., filled in at the District Court of The Hague on May 10, 1994 under No. 74/1994.



VAN WEEL KOELTECHNIEK B.V.

Address: Hoofdweg 92
2908 LC - Capelle a/d IJssel
Business: 010 450 30 84
Mobile: 06 518 36 116
E-Mail: aad@vanweelkoeltechniek.nl
Website: vanweelkoeltechniek.nl

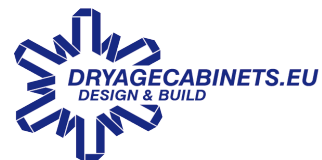

**Dry Age Cabinet
DACxDW-XL**

OTHER POSSIBILITIES

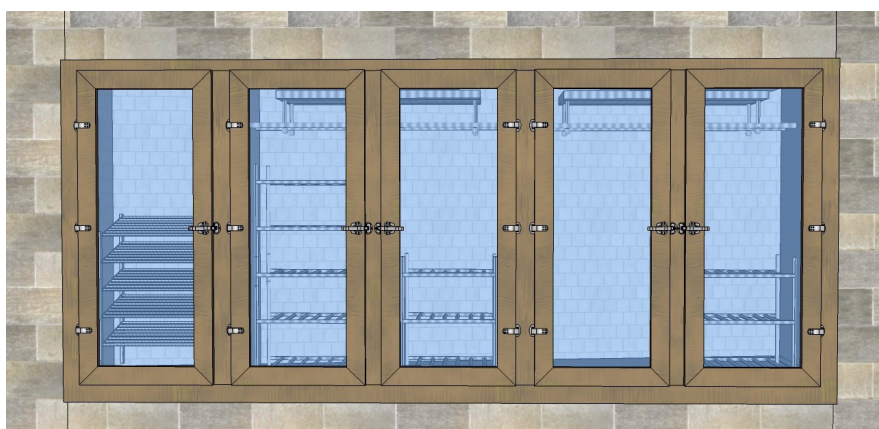
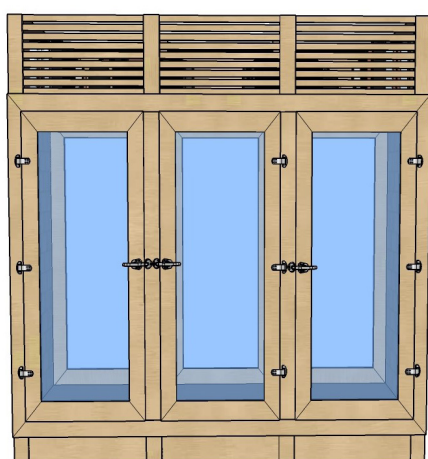
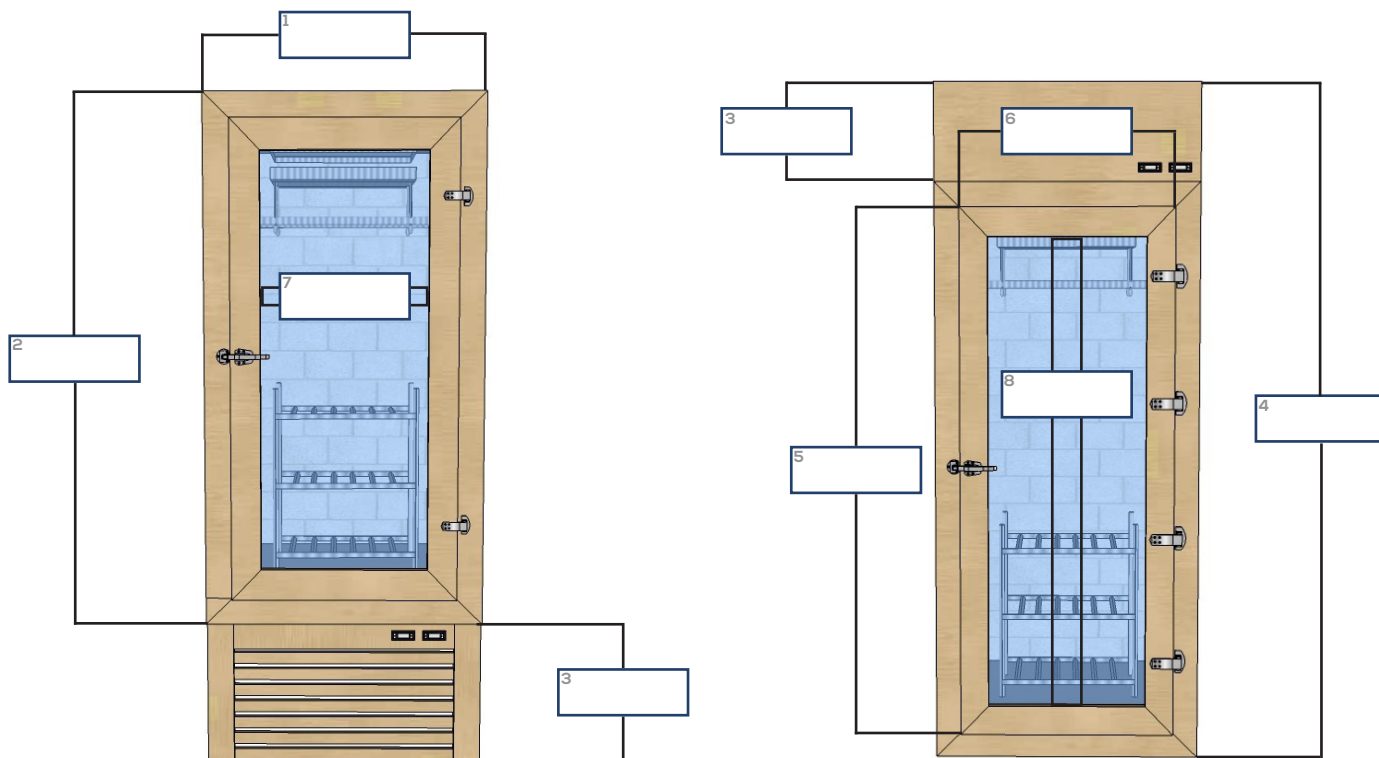

Installation does fully depend on customization.
Get in touch for more information.

General Delivery and Payment Conditions following the N.V.K.L., filled in at the District Court of The Hague on May 10, 1994 under No. 74/1994.

